



direccionales

serie
SHARP

serie SHARP

ACABADOS MELAMINA

BLANCO / OLIVO / ARCE / HAYA/ CEREZO / ROBLE / WENGUE / NOGAL / NOGAL VICTORIA

MESAS

- Encimeras fabricadas con tableros de M.D.F. de 25 mm. de espesor y de densidad de ± 950 Kg/m³
- Tableros con recubrimiento bilaminado decorativo de baja presión por ambas caras.
- Cantos moldurados y lacados con poliuretano. Color negro, blanco o a juego con la encimera.
- Aristas redondeadas con un radio de 50 mm.
- Roscas metálicas.

SHARP

- Pata de mesa formado por tubo metálico pintado en epoxi negro o blanco y con pies cromados.
- Niveladores de acero inoxidable de $\varnothing 75$ mm. de base y una regulación en altura de 15 mm.

STEEL

- Estructura de mesa en acero cónico, pintado en epoxi blanco, niveladores de acero inoxidable de 75 mm. \varnothing

DELTA

- Estructura de mesa en chapa de acero pintada en epoxi blanco.

BUC

- Encimeras fabricadas con tablero aglomerado con canto de 2 mm. de grosor.
- Cajón metálico negro con guías telescópicas metálicas de extracción parcial y capacidad de 12 kg.
- Archivo metálico negro con guías correderas de bolas de extracción total y capacidad de carga de 45 kg.
Juego de bastidor para carpetas colgantes de acero acabado epoxi color gris. Rueda en el frente del cajón para evitar el vuelco.
- Plumier compuesto por una bandeja para material de oficina de plástico negro.

ARMARIOS

- Estantes incorporados de 25 mm. de espesor.
- Cantos rectos de 2 mm. de grosor.
- Aristas redondeadas.
- Bisagras provistas de sistema autocierre y apertura a 110°
- Bisagras con apertura de 165° (Opcional).
- Puertas provistas de falleba.
- Archivos con guías telescópicas de extracción total con cerradura individualizada en cada cajón y llave maestra para ambos cajones.
- Tableros aglomerados de alta densidad ± 750 kg/m³
- Vitrinas de marco de madera con cristales al ácido de 5 mm. de espesor.
- Vitrinas de marco de aluminio con cerradura y cristales al ácido de 5 mm. de espesor.
- Niveladores de 1.5 cm. de regulación, regulables desde el interior.
- Tirador Blanco o aluminio.

CREDENZA

- Encimera fabricada con tablero de M.D.F. de 25 mm. de espesor y de densidad de ± 950 Kg/m³
- Módulo con 2 cajones en madera y puertas batientes.
- Cerradura interior.
- Tirador Blanco o aluminio.

serie SHARP Acabados

ACABADO BICOLOR (Canto lacado en blanco o negro)

Ejemplo: S.MR16._1_2_3

1) Color Pies:

- N- Negro (Con tiradores aluminio)
- B- Blanco (Con tiradores blancos)

2) Color Canto:

- N- Lacado en Negro
- B- Lacado en Blanco

3) Acabado Encimera:

B- Blanco A- Arce H- Haya R- Roble O- Olivo C- Cerezo N- Nogal
Nv- Nogal Victoria W- Wengue **RR** Roble rústico

ACABADO UNICOLOR (Canto lacado a juego con la encimera)

Ejemplo: S.MR16._1_3

1) Color Pies:

- N- Negro (Con tiradores aluminio)
- B- Blanco (Con tiradores blancos)

3) Acabado Encimera:

B- Blanco A- Arce H- Haya R- Roble O- Olivo C- Cerezo N- Nogal
Nv- Nogal Victoria W- Wengue **RR** Roble rústico

Acabados

B BLANCO - O OLIVO Y BLANCO - A ARCE - H HAYA - C CEREZO - R ROBLE - W WENGUE - N NOGAL - N NOGAL VICTORIA - RR ROBLE RÚSTICO

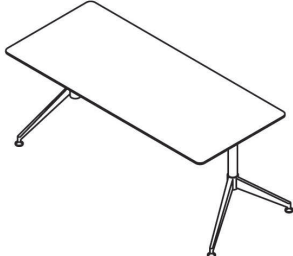
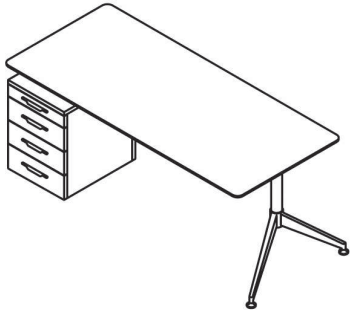
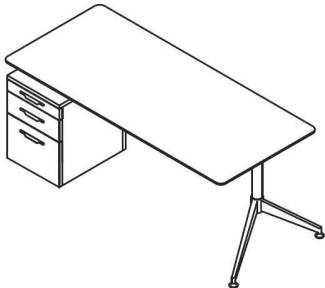
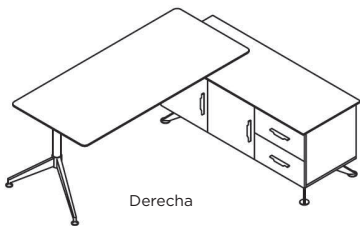
| | ANCHO X FONDO X ALTO | REF. | € |
|--|----------------------|----------------|-----------------|
| MESA SHARP | | | |
|  | 160 x 80 x 74 | S.MR16._1_2_3 | 489,25 |
| | 180 x 90 x 74 | S.MR18._1_2_3 | 509,85 |
| | 200 x 90 x 74 | S.MR20._1_2_3 | 530,45 |
| MESA SHARP CON BUC PEDESTAL DE CAJONES | | | |
|  | 172,5 x 80 x 74 | S.MR16C._1_2_3 | 669,50 |
| | 192,5 x 90 x 74 | S.MR18C._1_2_3 | 690,10 |
| | 212,5 x 90 x 74 | S.MR20C._1_2_3 | 710,70 |
| MESA SHARP CON BUC PEDESTAL DE CAJÓN Y ARCHIVO | | | |
|  | 172,5 x 80 x 74 | S.MR16A._1_2_3 | 669,50 |
| | 192,5 x 90 x 74 | S.MR18A._1_2_3 | 690,10 |
| | 212,5 x 90 x 74 | S.MR20A._1_2_3 | 710,70 |
| MESA SHARP CON CREDENCIA DE PUERTAS Y CAJONES DE MADERA | | | |
|  <p>Derecha</p> | 186 x 180 x 74 | S.MRD16._1_2_3 | 1.024,85 |
| | 206 x 180 x 74 | S.MRD18._1_2_3 | 1.045,45 |
| | 226 x 180 x 74 | S.MRD20._1_2_3 | 1.066,05 |



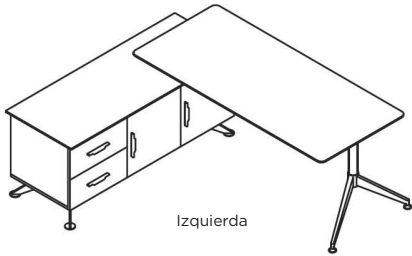
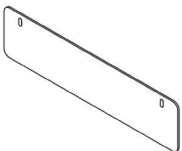
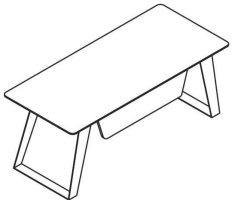
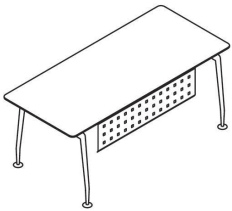
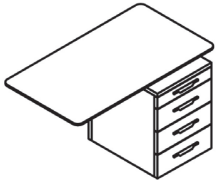
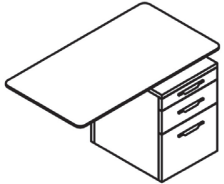

Acabados

B BLANCO - O OLIVO Y BLANCO - A ARCE - H HAYA - C CEREZO - R ROBLE - W WENGUE - N NOGAL - N NOGAL VICTORIA - RR ROBLE RÚSTICO

| | ANCHO x FONDO x ALTO | REF. | € |
|--|------------------------------------|------------------|-----------------|
| MESA SHARP CON CREDENCIA DE PUERTAS Y CAJONES DE MADERA | | | |
|  <p>Izquierda</p> | 186 x 180 x 74 | S.MR116._1_2_3 | 1.024,85 |
| | 206 x 180 x 74 | S.MR118._1_2_3 | 1.045,45 |
| | 226 x 180 x 74 | S.MR120._1_2_3 | 1.066,05 |
| FALDÓN MESA SHARP | | | |
|  | Para mesa 160 | S.F80_ | 81,37 |
| | Para mesa 180 | S.F100_ | 91,67 |
| | Para mesa 200 | S.F120_ | 101,97 |
| MESA DELTA (FALDÓN DE MESA INCLUIDO) | | | |
|  | 180 x 90 x 74 Estructura blanca | D.MR18B._2_3 | 960,99 |
| | 200 x 90 x 74 Estructura blanca | D.MR20B._2_3 | 981,59 |
| MESA STEEL (FALDÓN DE MESA INCLUIDO) | | | |
|  | 180 x 90 x 74 Estructura blanca | ST.MR18.B._2_3 | 960,99 |
| | 200 x 90 x 74 Estructura blanca | ST.MR20.B._2_3 | 981,59 |
| ALAS DE MESA CON BUC PEDESTAL (1 PLUMIER Y 3 CAJONES) | | | |
|  | 100 x 55 x 74 | S.ALA100C._1_2_3 | 409,94 |
| | 80 x 55 x 74 | S.ALA80C._1_2_3 | 404,79 |
| ALAS DE MESA CON BUC PEDESTAL (1 PLUMIER, 1 CAJÓN Y 1 ARCHIVO) | | | |
|  | 100 x 55 x 74 | S.ALA100A._1_2_3 | 409,94 |
| | 80 x 55 x 74 | S.ALA80A._1_2_3 | 404,79 |

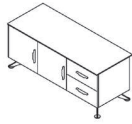
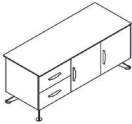

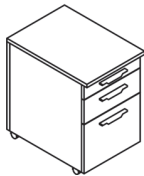
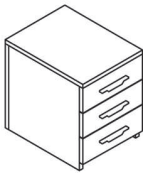
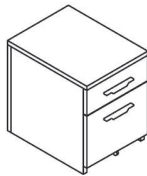
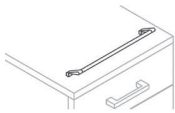
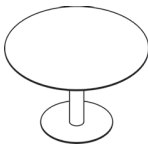
Acabados

B BLANCO - O OLIVO Y BLANCO - A ARCE - H HAYA - C CERZEJO - R ROBLE - W WENGUE - N NOGAL - N NOGAL VICTORIA - RR ROBLE RÚSTICO

| | ANCHO X FONDO X ALTO | | REF. | € |
|---|--|-----------------------------------|---------------|---------------|
| MESA RECTANGULAR CON ENCIMERA CON CANTOS LACADOS | | | | |
|  | 160 x 62 x 65,5 | DERECHO | S.AUXD._1_2_3 | 615,94 |
|  | 160 x 60 x 65,5 | IZQUIERDO | S.AUXI._1_2_3 | 615,94 |
| BUC DE RUEDAS | | | | |
|  | TIRADORES ALUMINIO 43,5 x 63,5 x 60,5 | 1 plumier y 3 cajones | S.BR3N_ | 251,32 |
| | TIRADORES BLANCOS 43,5 x 63,5 x 60,5 | | S.BR3B_ | |
|  | TIRADORES ALUMINIO 43,5 x 63,5 x 60,5 | 1 plumier, 1 cajón y 1 archivo | S.BRAN_ | 251,32 |
| | TIRADORES BLANCOS 43,5 x 63,5 x 60,5 | | S.BRAB_ | |
| BUC DE RUEDAS ECONÓMICO | | | | |
|  | TIRADORES ALUMINIO 43,5 x 56 x 55,5 | 3 cajones | SH.BR3N_ | 160,58 |
| | TIRADORES BLANCOS 43,5 x 56 x 55,5 | | SH.BR3B_ | |
|  | TIRADORES ALUMINIO 43,5 x 56 x 55,5 | 1 cajón y 1 archivo | SH.BRAN_ | 160,58 |
| | TIRADORES BLANCOS 43,5 x 56 x 55,5 | | SH.BRAB_ | |
| TIRADOR SUPERIOR PARA BUC DE RUEDAS (GRIS ALUMINIO) | | | | |
|  | 33 cm | Gris aluminio | T.SUP | 11,33 |
| MESAS DE JUNTAS CON UNA BASE DE COPA CROMADA | | | | |
|  | 120 Ø | Base cromada | S.MJ12._2_3 | 426,42 |
| MESAS DE JUNTAS CON UNA BASE DE TRES PIES | | | | |
|  | 120 Ø | Pie negro | S.MJ12.N_2_3 | 422,43 |
| | | Pie blanco | S.MJ12.B_2_3 | |

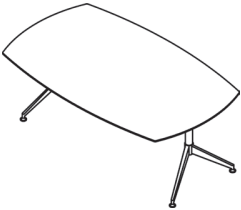
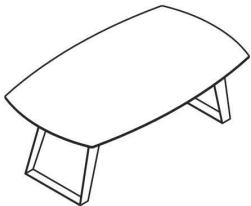
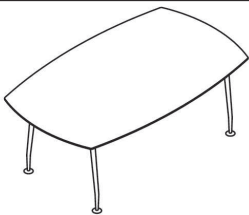
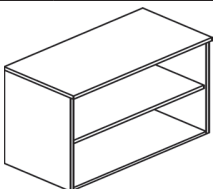
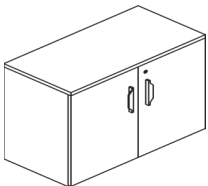

Acabados

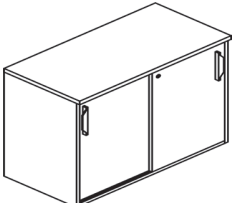
B BLANCO - O OLIVO Y BLANCO - A ARCE - H HAYA - C CEREZO - R ROBLE - W WENGUE - N NOGAL - N NOGAL VICTORIA - RR ROBLE RÚSTICO

| | | REF. | € |
|---|----------------|---------------|---------------|
| MESA DE JUNTAS SHARP CON ESTRUCTURA Y FALDÓN | | | |
|  | 200 x 120 x 74 | S.MJ20._1_2_3 | 569,59 |
| | 240 x 120 x 74 | S.MJ24._1_2_3 | 629,33 |
| | 280 x 120 x 74 | S.MJ28._1_2_3 | 691,13 |
| MESA DE JUNTAS DELTA CON ESTRUCTURA DE COLOR BLANCO | | | |
|  | 200 x 120 x 74 | D.MJ20.B_2_3 | 891,98 |
| | 240 x 120 x 74 | D.MJ24.B_2_3 | 952,75 |
| MESA DE JUNTAS STEEL CON ESTRUCTURA DE COLOR BLANCO | | | |
|  | 200 x 120 x 74 | ST.MJ20.B_2_3 | 891,98 |
| | 240 x 120 x 74 | ST.MJ24.B_2_3 | 952,75 |
| CON 1 ESTANTE | | | |
|  | 74 x 90 x 45 | R.VE3_ | 111,24 |
| CON 1 ESTANTE (PUERTAS BATIENTES) | | | |
|  | 74 x 90 x 45 | S.VB3_ | 162,44 |
| CON 2 ARCHIVOS | | | |
|  | 74 x 90 x 45 | S.VF3_ | 358,87 |
| CON 1 ESTANTE (PUERTAS CORREDERAS) | | | |
|  | 74 x 90 x 45 | S.VC3_ | 257,61 |



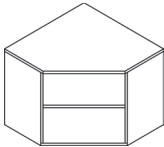
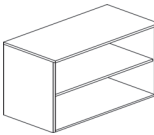
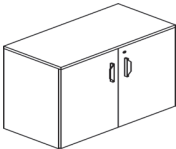
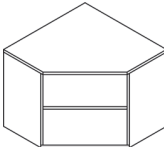
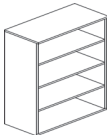
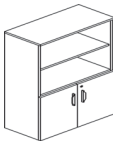

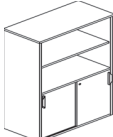
Acabados

B BLANCO - O OLIVO Y BLANCO - A ARCE - H HAYA - C CEREZO - R ROBLE - W WENGUE - N NOGAL - N NOGAL VICTORIA - RR ROBLE RÚSTICO

| | ALTO X ANCHO X FONDO | MELAMINA | |
|---|----------------------|----------|---------------|
| | | REF. | € |
| CON 1 ESTANTE | | | |
|  | 74 x 90 x 90 | R.VEX3_ | 227,86 |
| CON 1 ESTANTE | | | |
|  | 87 x 90 x 45 | R.VEAZ_ | 130,81 |
| CON 1 ESTANTE (PUERTAS BATIENTES) | | | |
|  | 87 x 90 x 45 | S.VBAZ_ | 188,19 |
| CON 1 ESTANTE | | | |
|  | 87 x 90 x 90 | R.VEXAZ_ | 265,74 |
| CON 3 ESTANTES | | | |
|  | 160 x 90 x 45 | R.VE2_ | 163,77 |
| CON 3 ESTANTES (PUERTAS BATIENTES) | | | |
|  | 160 x 90 x 45 | S.VB2_ | 214,97 |
| CON 3 ESTANTES (PUERTAS BATIENTES) | | | |
|  | 160 x 90 x 45 | S.VA2_ | 240,72 |
| CON 2 ESTANTES Y 2 ARCHIVADORES | | | |
|  | 160 x 90 x 45 | S.VF2_ | 411,40 |
| CON 3 ESTANTES (PUERTAS CORREDERAS) | | | |
|  | 160 x 90 x 45 | S.VC2_ | 324,30 |

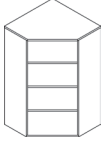
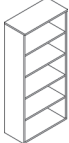

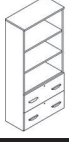
Acabados

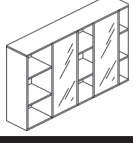
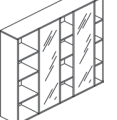
B BLANCO - O OLIVO Y BLANCO - A ARCE - H HAYA - C CEREZO - R ROBLE - W WENGUE - N NOGAL - N NOGAL VICTORIA - RR ROBLE RÚSTICO

| | ALTO X ANCHO X FONDO | MELAMINA | |
|---|----------------------|----------|---------------|
| | | REF. | € |
| CON 3 ESTANTES | | | |
|  | 160 x 90 x 90 | R.VEX2_ | 371,54 |
| CON 4 ESTANTES | | | |
|  | 200 x 90 x 45 | R.VE_ | 203,94 |
| CON 4 ESTANTES (PUERTAS BATIENTES) | | | |
|  | 200 x 90 x 45 | S.VB_ | 255,14 |
| CON 4 ESTANTES (PUERTAS BATIENTES) | | | |
|  | 200 x 90 x 45 | S.VA_ | 286,04 |
| CON 3 ESTANTES Y 2 ARCHIVOS | | | |
|  | 200 x 90 x 45 | S.VF_ | 451,57 |
| CON 4 ESTANTES (PUERTAS CORREDERAS) | | | |
|  | 200 x 90 x 45 | S.VC_ | 374,41 |
| CON 4 ESTANTES | | | |
|  | 200 x 90 x 90 | R.VEX_ | 471,77 |
| CON VITRINAS DE ALUMINIO CORREDERAS DE 45 CM | | | |
|  | 100 x 180 x 45 | R.V100 | 602,55 |
| CON VITRINAS DE ALUMINIO CORREDERAS DE 45 CM | | | |
|  | 160 x 180 x 45 | R.V160_ | 772,50 |

Acabados

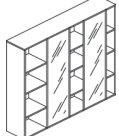
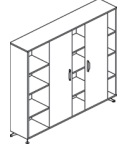
B BLANCO - O OLIVO Y BLANCO - A ARCE - H HAYA - C CERESO - R ROBLE - W WENGUE - N NOGAL - N NOGAL VICTORIA - RR ROBLE RÚSTICO

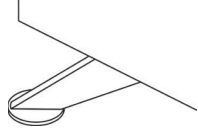
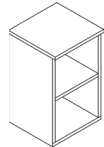
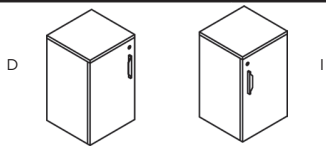
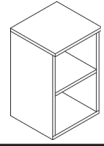
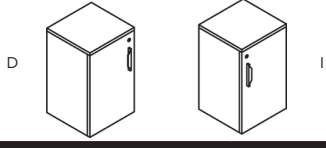
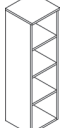
| | ALTO X ANCHO X FONDO | MELAMINA | |
|---|---------------------------|------------|---------------|
| | | REF. | € |
| CON VITRINAS CORREDERAS DE ALUMINIO | | | |
|  | 160 x 180 x 45 | R.V160_ | 772,50 |
| CON PUERTAS CORREDERAS DE MADERA (PIES CROMADOS INCLUIDOS) | | | |
|  | 172,5 x 180 x 45 | S.V160C_ | 523,30 |
| CON PUERTAS BATIENTES DE MADERA (PIES CROMADOS INCLUIDOS) | | | |
|  | 172,5 x 180 x 45 | S.V160P_ | 509,85 |
| CONJUNTO DE 4 PIES PARA ARMARIOS 4UD. (12,5 CM DE ALTO) | | | |
|  | (4 ud) 12,5 cm de alto | S.PV | 41,20 |
| CON 1 ESTANTE | | | |
|  | 74 x 45 x 45 | R.VE3_/5 | 80,18 |
| CON 1 ESTANTE Y PUERTA BATIENTE | | | |
|  | 74 x 45 x 45 | S.VB3_/5I | 104,91 |
| | | S.VB3_/5D | |
| CON 1 ESTANTE | | | |
|  | 87 x 45 x 45 | R.VEAZ_/5 | 92,80 |
| CON 1 ESTANTE Y PUERTA BATIENTE | | | |
|  | 87 x 45 x 45 | S.VBAZ_/5I | 121,90 |
| | | S.VBAZ_/5D | |
| CON 3 ESTANTES | | | |
|  | 160 x 45 x 45 | R.VE2_/5 | 120,51 |

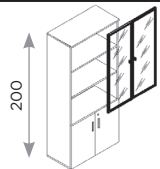
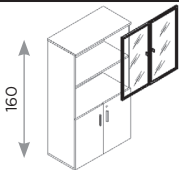
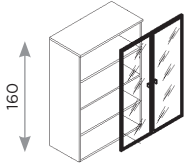
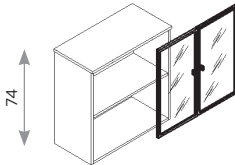
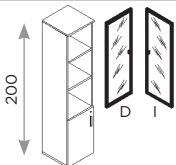
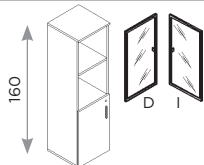
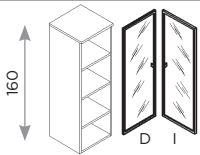
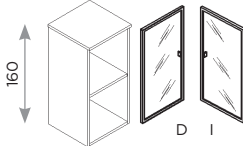
| VITRINAS CON MARCO DE ALUMINIO CON CERRADURA | | |
|---|--------------|---------------|
| | REF. | € |
| VITRINA DE MODELOS VB - VF - VC - MARCOS DE ALUMINIO | | |
|  | I.VITBML | 342,65 |
| VITRINA DE MODELOS VB2 - VF2 - VC2 - MARCOS DE ALUMINIO | | |
|  | I.VITB2ML | 264,25 |
| VITRINA DE MODELOS VE2 - MARCOS DE ALUMINIO | | |
|  | I.VITE2ML | 379,30 |
| VITRINA DE MODELOS VE3 - MARCOS DE ALUMINIO | | |
|  | I.VITE3ML | 264,25 |
| VITRINA DE MODELOS VB/5 - MARCOS DE ALUMINIO | | |
|  | I.VITBML/5I | 171,32 |
| | I.VITBML/5D | |
| VITRINA DE MODELOS VB2/5 - MARCOS DE ALUMINIO | | |
|  | I.VITB2ML/5I | 132,11 |
| | I.VITB2ML/5D | |
| VITRINA DE MODELOS VE2/5 - MARCOS DE ALUMINIO | | |
|  | I.VITE2ML/5I | 189,66 |
| | I.VITE2ML/5D | |
| VITRINA DE MODELOS VE3/5 - MARCOS DE ALUMINIO | | |
|  | I.VITE3ML/5I | 132,11 |
| | I.VITE3ML/5D | |